

[PORTA]

CATALOGUE 2020



DESTOCK
MENUISERIE



Caractéristiques de la porte

VANTAIL

Selon le lieu d'application et des fonctions de la porte à remplir, nous vous proposons les solutions les plus courantes en termes de structure du vantail et de ses éléments.



Dimensions de portes 1 vantail disponibles:
min. '60', max. '110'



Dimensions de portes 2 vantaux disponibles:
min. '90', max. '220'



Hauteur de vantail standard : 2040



Hauteur de vantail augmenté : 2200



L'épaisseur du vantail
dépend de la structure choisie



Version coulissante

STRUCTURE

Un vantail d'une structure **PANNEAU** est une porte composée d'un cadre et d'un remplissage disponible en trois versions:



alvéolaire



tubulaire



plein



Un vantail d'une structure **CADRE ET PANNEAU** (porte menuisée) est une porte composée d'éléments pleins et les espaces entre eux sont remplis de panneaux, de verre ou d'autres éléments décoratifs

CHAMBRANLE

Les principaux types de chambranles, ce sont les chambranles à chant droit et à recouvrement. Nous vous proposons des cadres aux dimensions fixes et des cadres ajustables à l'épaisseur du mur. De plus, les chambranles peuvent être équipés de cornières de 60 et 80 mm.



à chant droit



à recouvrement



réglage de chambranle



cornières de 60 et 80 mm

DESIGN, ESTHÉTIQUE

Notre offre répond à de nombreuses préférences. En sélectionnant le modèle, sa surface et les éléments tels que les marqueteries, les verres, la poignée et d'autres, vous pouvez adapter la porte à vos besoins.

Le type de finition de surface le plus courant est le placage synthétique. Il est durable et imite parfaitement le bois naturel. Certains modèles sont revêtus des placages naturels ou des vernis et des peintures de haute qualité.



placage naturel



peinture premium



teint acrylique UV

SENS D'OUVERTURE



GAUCHE TIRANT
DROIT POUSSANT



DROIT TIRANT
GAUCHE POUSSANT



GAUCHE POUSSANT PRINCIPAL
DROIT TIRANT PRINCIPAL

NORME DIMENSIONNELLE



dimensions françaises de modèles choisis disponibles en standard - sans plus value



dimensions françaises disponibles hors standard avec plus value

Porta LINE



Le design moderne avec des marqueteries minimalistes fait que cette porte répond aux dernières tendances. Une large gamme de modèles disponibles vous permet de choisir la porte qui correspond à l'esthétique de votre intérieur.

La collection des portes LINE est disponible en versions à recouvrement et à chant droit. Le chambranle est ajustable. Nous pouvons donc les installer dans la plupart des bâtiments



modèle A.1



modèle B.1



modèle C.1



modèle E.1



modèle F.1



modèle G.1



modèle H.1



modèle D.1

GAMME DE COULEURS

Portadecor

★★★★☆☆

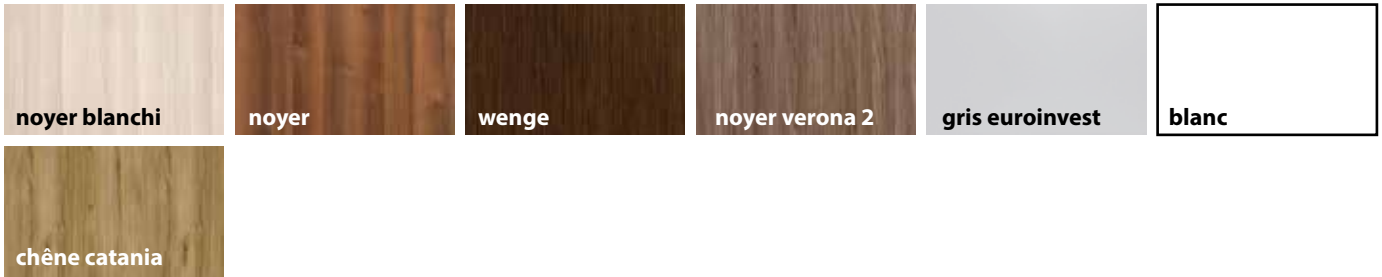

Portasynchro 3D

★★★★☆☆



Portaperfect 3D

★★★★☆☆



CPL HQ 0,2

★★★★☆☆



PERSONNALISATION



MARQUETÉRIES
ARGENTÉES OU
NOIRES SELON LA
COULEUR DE LA
PORTE

EN BREF

- PORTE ISOPLANE AVEC LÂME ALVEOLAIRE TUBULAIRE OU PLEIN
- VERSION À RECOUVREMENT ET À CHANT DROIT
- LARGE GAMME DE COULEURS ET MODÈLES
- DISPONIBLES EN VERSION SIMPLE, DOUBLE ET COULISSANTE
- CHAMBRANLE PERMET APPLICATION SUR LE MUR DE DIFFÉRENTS ÉPESSEURS

Porta VECTOR



Les portes blanches minimalistes égayeront votre intérieur. La multitude de modèles vous permettra de choisir la porte adaptée au style de votre habitation.

La collection Vector comprend les portes qui sont disponibles en divers remplissages et en revêtement vernis UV de qualité, grâce auquel le produit est résistant au jaunissement et aux facteurs mécaniques.



modèle A



modèle B



modèle C



modèle E



modèle Q



modèle T



modèle U



modèle V



modèle W



modèle Y

GAMME DE COULEURS

Vernis Premium

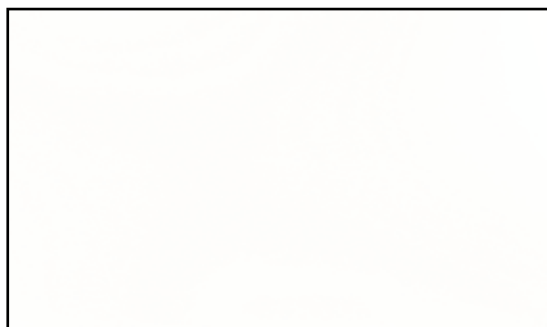

Grâce au vernissage de qualité premium, la porte est très résistante au vieillissement et aux facteurs mécaniques, ce qui lui permet de conserver son aspect esthétique pendant de nombreuses années.

Teint Acrylique UV

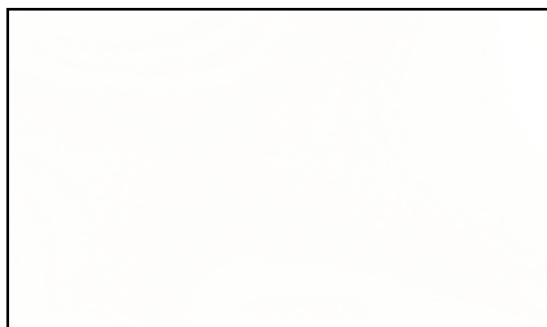

La peinture multicouche, qui subit un processus de durcissement par rayonnement UV, assure la plus haute résistance de la surface à la saleté (café, alcool, graisse),

- à l'abrasion,
- aux rayures,
- aux chocs.

QUALITÉ DE FINITION



EN BREF

- PORTE ISOPLANE AVEC L'ÂME ALVEOLAIRE TUBULAIRE OU PLEIN
- VERSION À RECOUVREMENT ET À CHANT DROIT
- LARGE GAMME DE MODÈLES
- DEUX TYPES DE FINITION, Y COMPRIS LE TEINT ACRYLIQUE UV
- DISPONIBLES EN VERSION SIMPLE, DOUBLE ET COULISSANTE
- CHAMBRANLE PERMET APPLICATION SUR LE MUR DE DIFFÉRENTS ÉPAISSEURS

Porta CPL



La collection de portes CPL est une proposition destinée pour les usages traditionnels. Les modèles de cette gamme répondent aux besoins esthétiques les plus fréquents

Il vaut la peine de souligner que ces portes sont disponibles en placage à haute résistance mécanique. On peut augmenter leur durabilité en ajoutant des panneaux.



modèle 1.1



modèle 1.2



modèle 1.3



modèle 1.4



modèle 1.5



modèle 5.1



modèle 5.2



modèle 5.4



modèle 5.5

GAMME DE COULEURS

CPL HQ 0,2

★★★★☆



HPL et CPL 0,7

★★★★★



ÉQUIPEMENT SUPPLÉMENTAIRE



panneau haut



panneau bas



panneau bas avec grille de ventilation



panneau bas avec coupe de ventilation

EN BREF

- PORTE ISOPLANE AVEC L'ÂME ALVEOLAIRE TUBULAIRE OU PLEIN
- VERSION À RECOUVREMENT ET À CHANT DROIT
- LARGE GAMME DE MODÈLES
- TRÈS HAUTE RÉSISTANCE MÉCANIQUE
- DISPONIBLES EN VERSION SIMPLE, DOUBLE ET COULISSANTE
- CHAMBRANLE PERMET APPLICATION SUR LE MUR DE DIFFÉRENTS ÉPAISSEURS

Porta DÉCOR



La collection Décor est une gamme classique de portes. Elle se compose de modèles très répandus parmi les utilisateurs qui apprécient la simplicité.

Une large gamme de couleurs ainsi que de différentes options de vitrage vous permettront d'adapter la porte à chaque intérieur.



modèle P



modèle M



modèle L



modèle D

GAMME DE COULEURS

Portadecor

★★★★☆☆

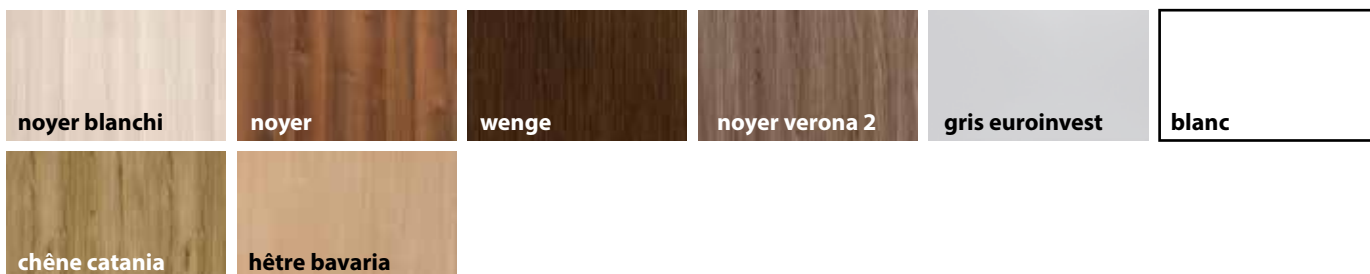

Portasynchro 3D

★★★★☆☆



Portaperfect 3D

★★★★☆☆



FINITION



finition encadrement



vitrage chinchilla

EN BREF

- PORTE ISOPLANE AVEC L'ÂME ALVEOLAIRE TUBULAIRE OU PLEIN
- VERSION À RECOUVREMENT ET À CHANT DROIT
- LARGE GAMME DE MODÈLES
- DISPONIBLES EN VERSION SIMPLE, DOUBLE ET COULISSANTE
- CHAMBRANLE PERMET APPLICATION SUR LE MUR DE DIFFÉRENTS ÉPAISSEURS

Porta FOCUS



La collection Focus disponible en 3 variantes est une combinaison de design moderne et minimaliste avec des éléments classiques.

Les portes sont parfaites pour les espaces modernes. Grâce à un large choix de placages, vous pouvez installer cette porte dans des différentes pièces.



modèle 2.0



modèle 4.A



modèle 4.B

GAMME DE COULEURS

Portadecor



Portasynchro 3D



Portaperfect 3D



CPL HQ 0,2



FINITION



vitrage - porte à chant droit



vitrage - porte à recouvrement

EN BREF

- PORTE ISOPLANE AVEC LÂME ALVEOLAIRE TUBULAIRE OU PLEIN
- VERSION À RECOUVREMENT ET À CHANT DROIT
- LARGE GAMME DE MODÈLES ET COULEURS
- DISPONIBLES EN VERSION SIMPLE, DOUBLE ET COULISSANTE
- CHAMBRANLE PERMET APPLICATION SUR LE MUR DE DIFFÉRENTS ÉPAISSEURS

Porta RESIST



La porte Resist, c'est un design haut de gamme. Le produit est disponible en quatre couleurs qui ont été soigneusement sélectionnées pour correspondre aux tendances courantes en design.

De plus, ce produit est extrêmement durable. Le panneau de finition a une haute résistance mécanique est efficace même dans des endroits encombrés comme les hôtels.

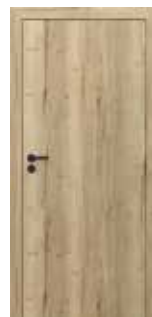

modèle 1.1



modèle 1.2



modèle 1.3



modèle 1.4

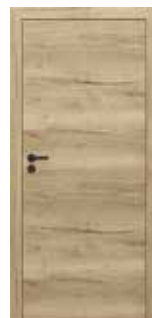

modèle 7.1



modèle 7.2



modèle 7.3



modèle 7.4



modèle B.1



modèle E.1



modèle H.1



modèle 4.A



modèle 4.B

GAMME DE COULEURS

Gladstone/Halifax

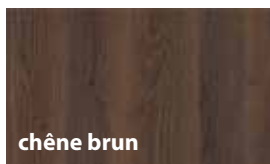
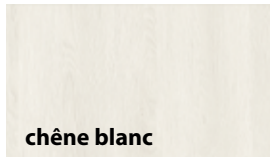

NOTRE RECOMMANDATION

La porte est recouverte d'un panneau fait de très petits éléments de bois liés sous haute pression. Cela garantit une résistance mécanique exceptionnelle



FINITION



le placage Halifax imite parfaitement la structure naturelle du bois



les marqueteries ajoutent de l'élégance à la porte, elles sont également disponibles en argent



détail de vitrage

EN BREF

- PORTE ISOPLANE AVEC L'ÂME ALVEOLAIRE TUBULAIRE OU PLEIN
- VERSION À RECOUVREMENT ET À CHANT DROIT
- LARGE GAMME DE MODÈLES
- TRÈS HAUTE RÉSISTANCE MÉCANIQUE
- DISPONIBLES EN VERSION SIMPLE, DOUBLE ET COULISSANTE
- CHAMBRANLE PERMET APPLICATION SUR LE MUR DE DIFFÉRENTS ÉPAISSEURS

Verte PREMIUM E



Les portes de la collection Verte Premium vous offrent avant tout la plus grande fiabilité de fabrication des cadres et de remplissage de panneaux ou de verre.

Un design minimaliste et intemporel en combinaison avec un nombre de couleurs raisonnable vous permet de personnaliser les portes selon vos préférences



modèle E.0



modèle E.1



modèle E.2



modèle E.3



modèle E.4



modèle E.5

GAMME DE COULEURS

Portadecor

★★★★☆☆



Portasynchro 3D

★★★★☆☆

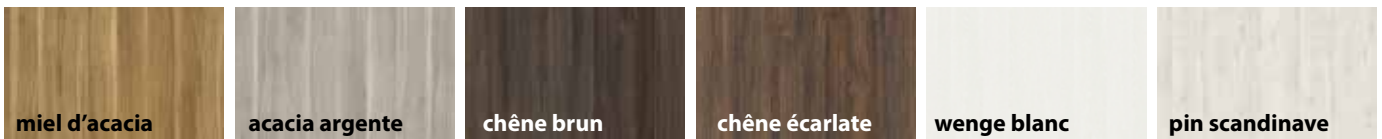

Portaperfect 3D

★★★★☆☆



DETAILS DE FINITION



panneau plat



vitrage mat

EN BREF

- PORTE MENUISÉE
- VERSION A RECOUVREMENT ET A CHANT DROIT
- LARGE GAMME DES COULEURS ET MODÈLES
- DISPONIBLES EN VERSION SIMPLE, DOUBLE ET COULISSANTE
- CHAMBRANLE PERMET APPLICATION SUR LE MUR DE DIFFERENTS ÉPAISSEURS

Verte HOME G



Les portes de la collection Verte HOME, toujours dépourvues de décorations inutiles, sont une proposition idéale pour les amateurs d'intérieurs simples et calmes

Une possibilité de choisir parmi de nombreux placages de différentes couleurs et de choisir une couleur différente des panneaux vous permet d'adapter la porte à vos préférences.



modèle G.0



modèle G.1



modèle G.2



modèle G.3



modèle G.4



modèle G.0
marqueteries



modèle G.4
marqueteries



GAMME DE COULEURS - PORTE

Portadecor



Portasynchro 3D



Portaperfect 3D



GAMME DE COULEURS - BAGUETTE DÉCORATIVE

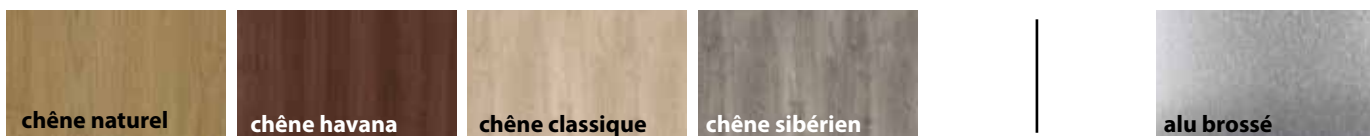

DETAILS DE FINITION



vitrage modèle G.4



marqueteries aluminium



le niveau des panneaux sur un vantail dépasse le niveau de la baguette décorative



baguette décorative aluminium

EN BREF

- PORTE MENUISÉE
- BAGUETTE DÉCORATIVE PERMET PERSONNALISATION DE PORTE
- VERSION A RECOUVREMENT ET A CHANT DROIT
- LARGE GAMME DES COULEURS ET MODÈLES
- DISPONIBLES EN VERSION SIMPLE, DOUBLE ET COULISSANTE
- CHAMBRANLE PERMET APPLICATION SUR LE MUR DE DIFFERENTS ÉPAISSEURS

Verte HOME H



Verte Home est un groupe de portes conçues pour les intérieurs modernes et minimalistes

Un design intemporel et une large gamme de couleurs vous permettent d'adapter votre porte même aux intérieurs les plus exigeants.



modèle H.0



modèle H.1



modèle H.2



modèle H.3



modèle H.4



modèle H.5



S

120 - 200

60 - 100

40 mm

GAMME DE COULEURS - PORTE

Portadecor



noyer blanchi

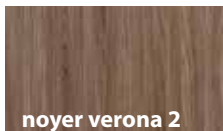

noyer verona 2



chêne catania



blanc

Portasynchro 3D



miel d'acacia



acacia argente

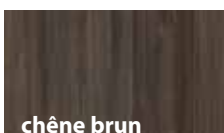

chêne brun

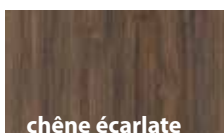

chêne écarlate

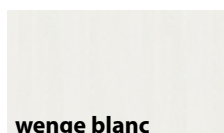

wenge blanc



pin scandinave

Portaperfect 3D



hêtre

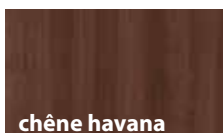

chêne havana



chêne californie



chêne classique



chêne sibérien



chêne malibu



chêne naturel

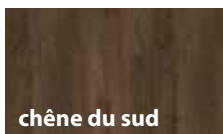

chêne du sud



chêne scandinave

GAMME DE COULEURS - BAGUETTE DÉCORATIVE



chêne naturel

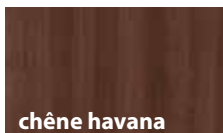

chêne havana



chêne classique



chêne sibérien



alu brossé

DETAILS DE FINITION



baguette modèle H.0



vitrage modèle H.5



le niveau des panneaux sur un vantail dépasse le niveau de la baguette décorative

EN BREF

- PORTE MENUISÉE
- BAGUETTE DÉCORATIVE PERMET PERSONNALISATION DE PORTE
- VERSION A RECOUVREMENT ET A CHANT DROIT
- LARGE GAMME DES COULEURS ET MODÈLES
- DISPONIBLES EN VERSION SIMPLE, DOUBLE ET COULISSANTE
- CHAMBRANLE PERMET APPLICATION SUR LE MUR DE DIFFERENTS ÉPAISSEURS

Mardid Cordoba Toledo



La porte classique recouverte de placage naturel confère à l'intérieur un caractère exclusif. Les portes sont disponibles en trois styles et plusieurs variants en fonction de proportions de remplissage (remplissage plein/remplissage en verre).

Nous avons veillé à ce que la protection faite en placage naturel soit de la plus haute qualité. Grâce à cela les portes Madrid, Cordoba et Toledo vous permettront de profiter de leur beauté naturelle pendant de nombreuses années.



Madrid plein



Madrid p.vitrage



Madrid vitrage



Mardid g.vitrage



Cordoba plein



Cordoba p.vitrage



Cordoba vitrage



Cordoba g.vitrage



Toledo plein



Toledo p.vitrage



Toledo vitrage



Toledo g.vitrage



GAMME DE COULEURS

Placage naturel chêne satiné



chêne blanc

tabacco

mocca

nero

chêne clair

chêne Winchester

chêne brun

Placage naturel chêne



chêne 1

FINITION



MADRID cadre
décoratif profilé



CORDOBA cadre
minimaliste 20°



MADRID panneau
décoratif



TOLEDO cadre
minimaliste 20°

EN BREF

- PORTE MENUISÉE
- VERSION À RECOUVREMENT ET À CHANT DROIT
- LARGE GAMME DE MODÈLES
- PLACAGE NATUREL HAUTE QUALITÉ
- DISPONIBLES EN VERSION SIMPLE, DOUBLE ET COULISSANTE
- CHAMBRANLE PERMET APPLICATION SUR LE MUR DE DIFFERENTS ÉPAISSEURS

PORTE CLIMAT



Le produit a été conçu pour séparer le garage de la partie résidentielle de la maison de manière sûre et confortable.

La structure remplit d'un panneau perforé avec des feuilles d'aluminium supplémentaires et un joint automatique fournit une isolation thermique. La porte est équipée d'une serrure multipoint avec un cylindre, ce qui augmente considérablement votre sécurité.



Marqueteries 1



Marqueteries 3



Marqueteries 4



Marqueteries 6



Marqueteries 7



Marqueteries 8



Marqueteries 9



modèle plat horizontal



modèle plat vertical

GAMME DE COULEURS

CPL HQ 0,2

★★★★☆

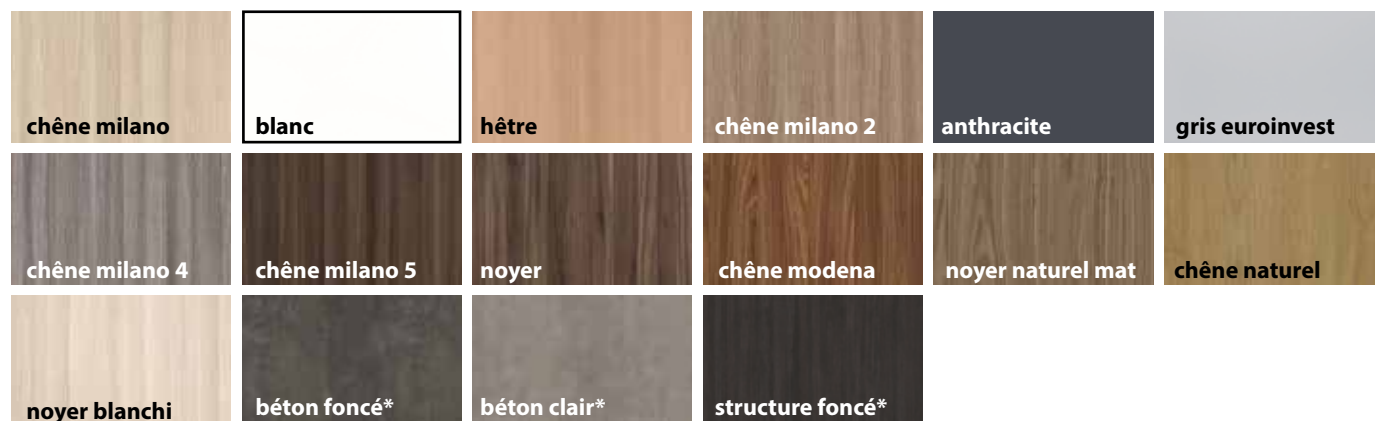

HPL et CPL 0,7

★★★★★

Gladstone/Halifax

★★★★★



l'âme tubulaire avec
deux couches
d'aluminium



cylindre à bouton ou
simple



joint automatique

EN BREF

- PORTE PLANE EN L'AME TUBULAIRE OU PLEIN
- PLANCHES ALU AUGMENTE ISOLATION
- SERRURE MULTIPOINT AVEC CYLINDRE
- VERSION A RECOUVREMENT
- LARGE GAMME DES COULEURS ET MODÈLES
- DISPONIBLES EN VERSION SIMPLE
- CHAMBRANLE ACIER OU PORTA SYSTEM
- CHAMBRANLE PERMET APPLICATION SUR LE MUR DE DIFFERENTS ÉPAISSEURS

Systemes coulissants



Les portes coulissantes fonctionnent bien dans les espaces limités où l'ouverture de la porte de manière traditionnelle est difficile.

Notre offre comprend des systèmes installés sur et dans les murs. Tous les éléments des systèmes sont cohérents en termes de conception, ils forment donc un tout très bien composé et pratique.



SYSTEME PORTA

- SYSTEME MURAL
- TOUS LES ÉLÉMENTS DU SYSTEME SONT DISPONIBLES DANS DES COULEURS CORRESPONDANTES AUX COULEUR DES VANTAUX
- IL EST PARFAITEMENT ADAPTÉ AUX MURS ÉTROITS SITUÉS DANS LES PIÈCES OÙ IL N'Y A PAS D'ESPACE POUR LES PORTES POUSSANTES
- LE SYSTEME SE COMPOSE D'UN VANTAIL COULISSANT, D'UN SYSTEME COULISSANT AVEC UNE CACHE ET UN CHAMBRANLE TYPE TUNNEL



SYSTEME COMPACT

- SYSTEME INTRAMURAL
- IL PERMET DE CACHER LA PORTE OUVERTE DE MANIÈRE TRÈS ESTHETIQUE
- LES COULEURS DES ÉLÉMENTS INDIVIDUELS CORRESPONDENT AUX COULEURS DES PORTES
- L'INSTALLATION DU SYSTEME NÉCESSITE UN MUR D'ÉPAISSEUR DE 125 MM
- L'ENSSEMBLE INCLUT UNE VANTAIL COULISSANTE, UN BÂTI DE 2 X 62,5 MM ET UNE CASSETTE STRUCTURELLE



POIGNÉES



UNICO



CLÉ
STANDARD



WC



CYLINDRE



ANTHRACITE
STRUCTURÉ
NOIR
STRUCTURÉ



ORGANIC



CLÉ
STANDARD



WC



CYLINDRE



ANTHRACITE
STRUCTURÉ
NOIR
STRUCTURÉ



ACCENT



CLÉ
STANDARD



WC



CYLINDRE



ARGENT
ARGENT MAT
OR MAT



MODERN



CLÉ
STANDARD



WC



CYLINDRE



ARGENT
ARGENT MAT
OR MAT



NEXT



CLÉ
STANDARD



WC



CYLINDRE



ARGENT
ARGENT MAT
OR MAT

POIGNÉES



OFFICE



CLÉ
STANDARD



WC



CYLINDRE



ARGENT



ARGENT MAT



OR MAT



ANTHRACITE



OR



CARO



CLÉ
STANDARD



WC



CYLINDRE



ARGENT



ARGENT MAT



OR MAT



TOPAZ



CLÉ
STANDARD



WC



CYLINDRE



ACIER
INOXYDABLE



EUROFIA



CLÉ
STANDARD



WC



CYLINDRE



NOIR



CUBE



CLÉ
STANDARD



WC



CYLINDRE



NICKEL BROSEE
MAT



CHROME BROSEE
MAT

POIGNÉES



ELEGANT



CLÉ
STANDARD



WC



CYLINDRE



ARGENT

BLANC

NOIR



SIMPLE



CLÉ
STANDARD



WC



CYLINDRE



ARGENT

BLANC

NOIR



ISA



CLÉ
STANDARD



WC



CYLINDRE



CHROME POLI

CHROME SATINE

NOIR



FUSSA



CLÉ
STANDARD



WC



CYLINDRE



CHROME POLI

CHROME SATINE

NOIR



JULIA



CLÉ
STANDARD



WC



CYLINDRE



CHROME POLI

POIGNÉES



BRAVA



CLÉ
STANDARD



WC



CYLINDRE



CHROME



CHROME BROSSÉ



NOIR



DIVO FIT - R



CLÉ
STANDARD



WC



CYLINDRE



CHROME



CHROME SATINEÉ



NOIR



DIVO FIT - O



CLÉ
STANDARD



WC



CYLINDRE



CHROME



CHROME SATINEÉ



NOIR



UNO 3S



CLÉ
STANDARD



WC



CYLINDRE



ACIER
INOXYDABLE



DUE 3S



CLÉ
STANDARD



WC



CYLINDRE



ACIER
INOXYDABLE

Chambranle PORTA SYSTEM

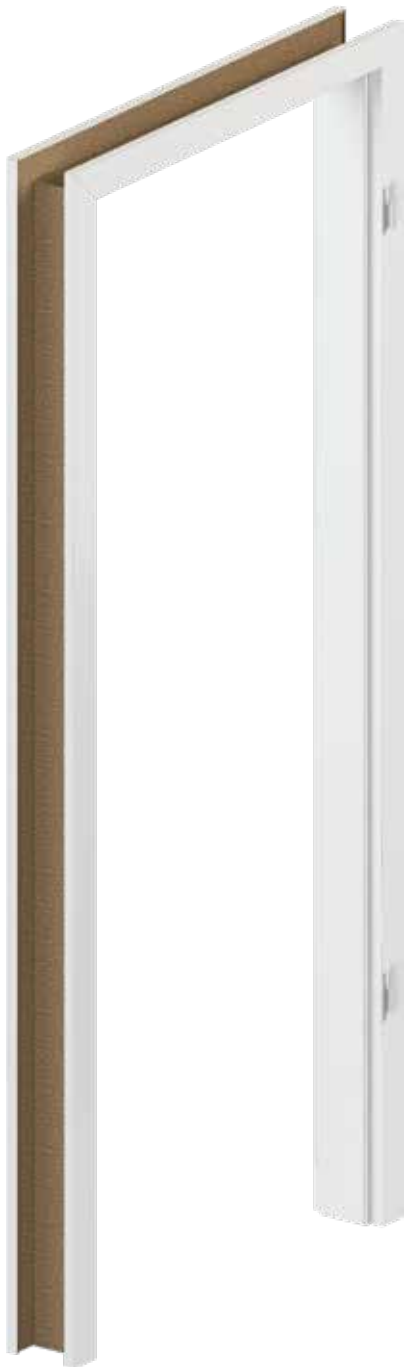

Le chambranle PORTA SYSTEM est installé après que les murs et les sols ont été finis.

La disponibilité du produit dans toutes les couleurs permet de l'adapter à chaque modèle de la porte **À RECOUVREMENT** incluse dans le catalogue. Un large éventail de réglages permet aux portes d'être utilisées dans la plupart des bâtiments.

SECTION



RÉGLAGE DE DIMENSION

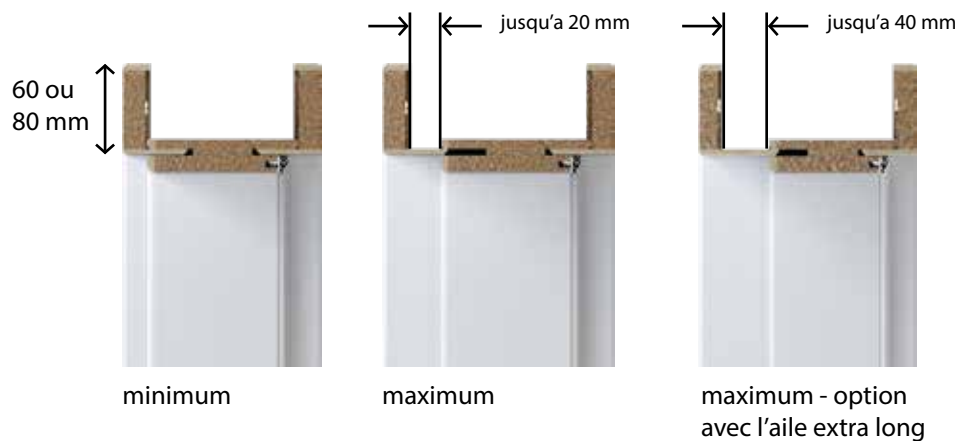

DIMENSIONS

A	B C	D E	F G H	I J K
75-95	95-115 120-140	140-160 160 - 180	180-200 200-220 220-240	240-260 260-280 280-300

PANNEAU DE RÉGULATION



Chambranle PORTA SYSTEM ELEGANCE



Le chambranle PORTA SYSTEM ELEGANCE est installé après que les murs et les sols ont été finis.

La disponibilité du produit dans toutes les couleurs permet de l'adapter à chaque modèle de la porte À CHANT DROIT incluse dans le catalogue. Un large éventail de réglages permet aux portes d'être utilisées dans la plupart des bâtiments.

SECTION



REGULATION DE DIMENSION

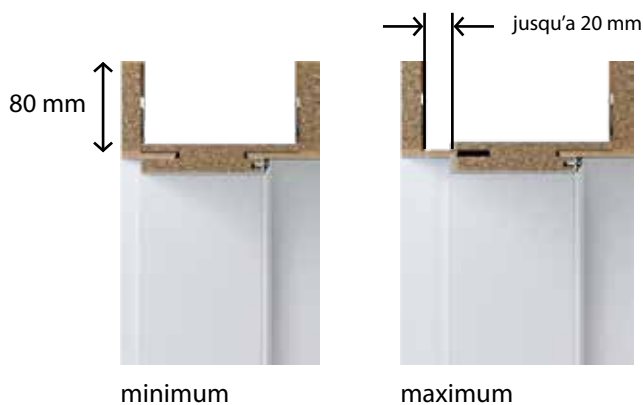

DIMENSIONS

A	B C	D E	F G H	I J K
75-95	95-115 120-140	140-160 160 - 180	180-200 200-220 220-240	240-260 260-280 280-300

CHARNIERS 3D



charniere 3D
porte fermee



charniere 3D
porte ouvert

Chambranle RENOVA

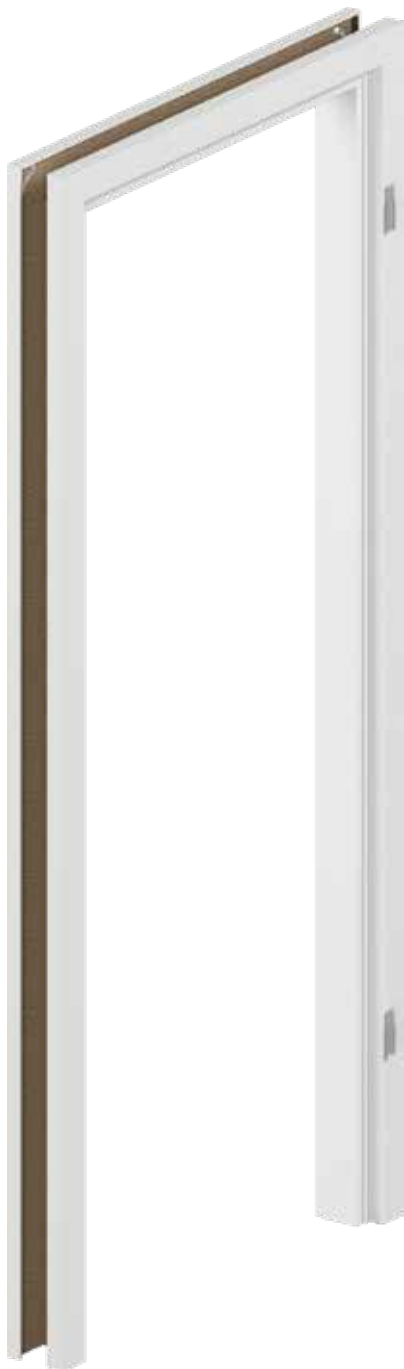

Renova est un produit destiné aux pièces où on veut remplacer ses portes et on souhaite limiter les travaux associés à l'enlèvement de l'ancien cadre. Renova s'installe directement sur le chambranle existant.

La disponibilité du produit dans toutes les couleurs permet de l'adapter à chaque modèle de la porte **À RECOUVREMENT** incluse dans le catalogue. Un large éventail de réglages permet aux portes d'être utilisées dans la plupart des bâtiments.

SECTION



REGULATION DE DIMENSION



minimum



maximum

DIMENSIONS

5	A	B C	D E	F G H	I J K
55-75	75-95	95-115 120-140	140-160 160 - 180	180-200 200-220 220-240	240-260 260-280 280-300



Tableau de dimensions

PORTA SYSTEM PORTE À RECOUVREMENT

PORTA SYSTEM ELEGANCE PORTE À CHANT DROIT

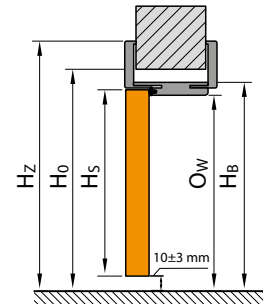
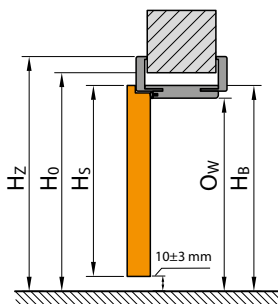
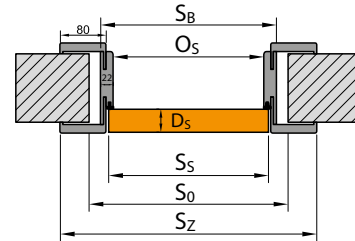
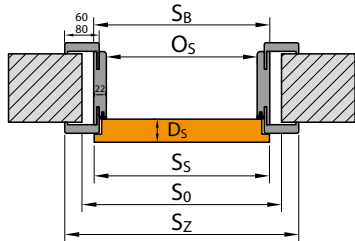

CHAMBRANLE	Dimension	S _s	H _s	D _s	S _o	H _o	O _s	O _w	S _b	H _b	S _z (6)	S _z (8)	H _z	T
Porta System	60	644	2030	40	680	2060	602	2016	646	2038	746	786	2088 corniere 60 2108 corniere 80	L+20 H+10
	70	744			780		702		746		846	886		
	80	844			880		802		846		946	986		
	90	944			980		902		946		1046	1086		
	100	1044			1080		1002		1046		1146	1186		
	110	1144			1180		1102		1146		1246	1286		
Porta System Elegance	60	618	2017	40	680	2060	602	2016	646	2038	-	786	2108	L+20 H+10
	70	718			780		702		746		886			
	80	818			880		802		846		986			
	90	918			980		902		946		1086			
	100	1018			1080		1002		1046		1186			

Porta System	60	630	2040	40	666	2070	588	2026	632	2048	732	772	2098 corniere 60 2118 corniere 80	L+20 H+10
	70	730			766		688		732		832	872		
	80	830			866		788		832		932	972		
	90	930			966		888		932		1032	1072		
	100	1030			1066		988		1032		1132	1172		
	110	1130			1166		1088		1132		1232	1272		
Porta System Elegance	60	630	2040	40	692	2083	614	2026	658	2061	-	798	2131	L+20 H+10
	70	730			792		714		758		898			
	80	830			892		814		858		998			
	90	930			992		914		958		1098			
	100	1030			1092		1014		1058		1198			

Tableau de dimensions

PORTA RENOVA PORTE À RECOUVREMENT

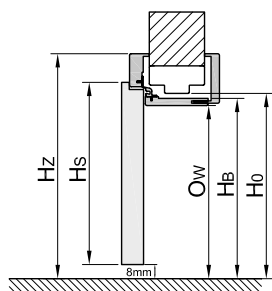
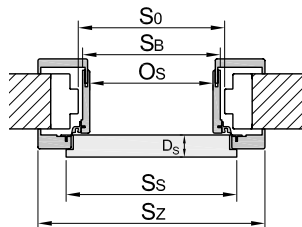

CHAMBRANLE ACIER PORTE À RECOUVREMENT

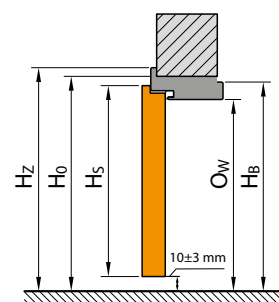
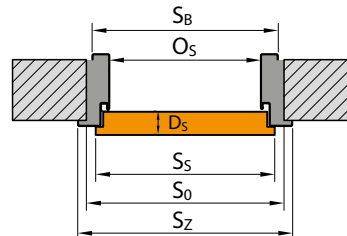

CHAMBRANLE	Dimension	Ss	Hs	Ds	So	Ho	Os	Ow	Sb	Hb	Sz(6)	Sz(8)	HZ	T
Renova	60	644	2030	40	596	2016	558	1994	584	2007	746	-	2088	L+15 H-6
	70	744			696		658		684		846	-		
	80	844			796		758		784		946	-		
	90	944			896		858		884		1046	-		
	100	1044			996		958		984		1146	-		
	110	1144			1096		1058		1084		1246	-		
Acier pour Porte Climat	60	644	2030	40	675	2055	596	2013	656	2043	706	-	2068	L+10 H+5
	70	744			775		696		756		806	-		
	80	844			875		796		856		906	-		
	90	944			975		896		956		1006	-		
	100	1044			1075		996		1056		1106	-		



Renova 	60	630	2040	40	582	2026	544	2004	570	2017	732	-	2098	L+15 H-6
	70	730			682		644		670		832	-		
	80	830			782		744		770		932	-		
	90	930			882		844		870		1032	-		
	100	1030			982		944		970		1132	-		
	110	1130			1082		1044		1070		1232	-		
Acier pour Porte Climat 	60	630	2040	40	661	2065	582	2023	642	2053	692	-	2078	L+10 H+5
	70	730			761		682		742		792	-		
	80	830			861		782		842		892	-		
	90	930			961		982		942		992	-		
	100	1030			1061		1082		1042		1092	-		

Tableau de dimensions

COULISSANTE PORTA



COULISSANTE COMPACT

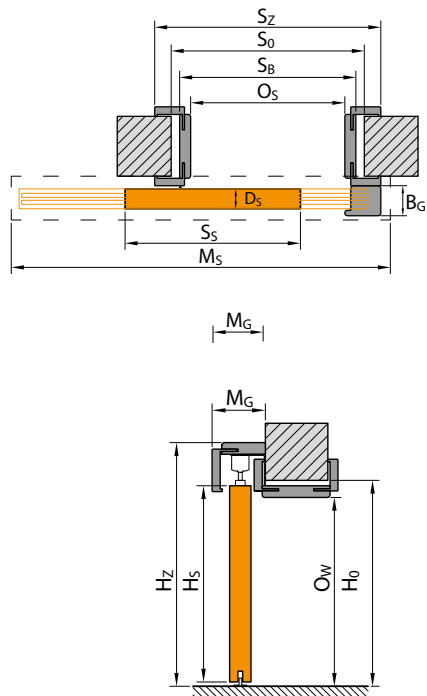
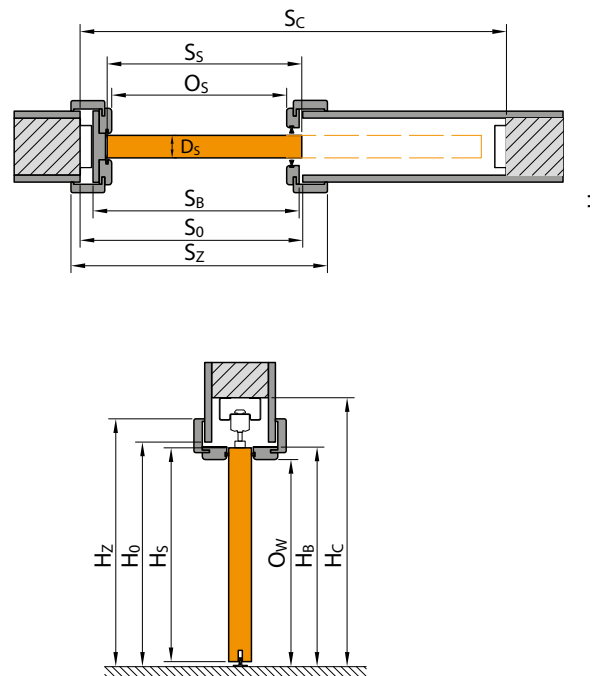

CHAM-BRANLE	Dimension	Ss	Hs	Ds	So	Ho	Os	Ow	Sb	Hz	Ms	Mg	Bg	T
PORTA	60	644	2030	40	680	2060	602	2016	646	2119	1413	103	60	L+20 H+10
	70	744			780		702		746		1613			
	80	844			880		802		846		1813			
	90	944			980		902		946		2013			
	100	1044			1080		1002		1046		2213			

CHAM-BRANLE	Dimension	Ss	Hs	Ds	So*	Ho*	Os	Ow	Sb	Hb	Sz(6)	Sz(8)	Hz (6)/(8)	Sc	Hc	T
COMPACT	60	644	2030	40	660	2065	600	2018	654	2040	744	784	2090/ 2110	1355	2130	L+5 H+10
	70	744			760		700		754		844	884		1555		
	80	844			860		800		854		944	984		1755		
	90	944			960		900		954		1044	1084		1955		
	100	1044			1060		1000		1054		1144	1184		2155		



07 50 70 53 43

06 76 25 12 55